

Article number: 20484M830ELS
 Description: E+G T-swivel mounting
 GN 484-M8-30-ELS

Measures

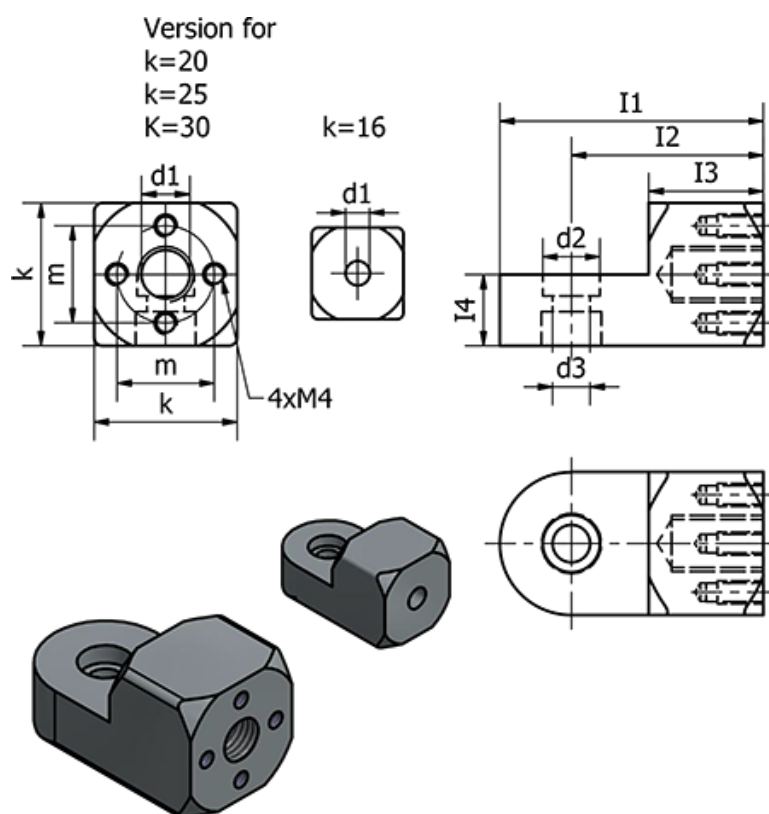

Clamping kit for d3 Type K = GN 511.1-M6-30-K

Clamping kit for d3 Type S = GN 511.1-M6-30-S

d1 = M8

d2 = 10

d3 = 6.5

I1 = 55

I2 = 40

I3 = 24

I4 = 15

k = 30

m = 20

Weight (g) = 58